



90 MM MODULES



90 MM MODULES – **Powerful and reliable**

HELLA headlamp modules stand for the highest quality, reliability and cost efficiency.

Whether a bus, tractor, truck, motorhome or motorcycle: HELLA's robust headlamp modules are used in many vehicle types. Thanks to their modular design, they offer maximum flexibility and a wide range of possible applications. The headlamp module range offers a choice between halogen and LED technology depending on requirements, so enabling an easy switch from halogen to LED. All modules impress with their robust construction and can therefore be used in demanding work environments. They are all powerful, durable and reliable and thus stand for safety.

The difference lies in the detail: In the 90 mm series, the L 4060 LED modules in particular outshine others with their outstanding light output and additional lighting functions. The Bi-LED modules combine low beam and high beam in a single headlamp module – ideal for vehicles with limited space or special designs.

You can rely on HELLA expertise when selecting the right headlamp module. All our products guarantee a high level of safety and quality while being cost-efficient at the same time.





TABLE OF CONTENTS

Introduction	2
The module selector	4
Legend for icons	5
Product overview	6

90 mm modules

LED / Essential – Low beam and high beam	8
LED / Performance – Low beam:	10
LED / Performance – High beam	12
LED / Performance – Fog light	14
Bi-LED / Performance – Low beam and high beam	16
Bi-Halogen / Performance – Low beam and high beam	18
Halogen / Essential - Low beam and high beam	20

Light distributions	22
---------------------	----

Mounting kits and carrier frames	24
Accessories	26
Type approvals	28
FAQ	30
Contact	31



A SOPHISTICATED SOLUTION: the smart module selector

Find the right headlamp module with just a few clicks:

Our smart module selector will make your search easier. Simply use the filter to select the required criteria such as the lighting function or homologation and you'll see suitable products right away.

www.hella.com/headlamp-modules



+ Simple menu structure and use

Our module selector is easy to use and makes it simple for original equipment manufacturers and end customers to find the right module - just like its predecessor, which has already proved its worth in practical use. We have built on this and added further module types to the configurator.

+ Illumination comparison

You can compare the lighting technology for selected main lighting functions. Spot the difference between halogen and LED with realistic images from Europe's largest light testing facility! Compare the light distribution and make the right decision for your application.

+ Upgrade to modern LED technology

Existing halogen versions can be easily converted to LED modules. More detailed information is found in the assembly instructions supplied with the LED modules.

+ It's easy to order parts

Use the selector to easily create your order list and send it to HELLA.

LEGEND

Icons at a glance



ECE
This product is approved in accordance with ECE guidelines.



Asymmetrical light distribution
The product complies with ECE regulation R112, which regulates asymmetrical low beam for passenger cars, buses, commercial vehicles and most larger vehicles.



Symmetrical light distribution
The product complies with ECE regulation R113, which regulates symmetrical low beam for many agricultural vehicles and lighter vehicles (2, 3 or 4 wheels).



SAE
The product meets the FMVSS 108 or the ASABE S0608 type approval.



CCC
Please contact us for the current certificate.



Vehicle electrical system voltage
Defines the power supply of the light.
This can be 12 V, 24 V or a flexible voltage range for multi-voltage (e.g. 8 – 33 V).



Operating temperature
Thermal management and an optimised housing design guarantee full functionality for all operating temperatures through product testing e.g. from -40°C to 60°C.



Dust and water protection class IP
International Protection (IP) according to DIN 40050 Part 9. Specific definition for road vehicles:

First digit: Protection against dust and dirt
5K = dust protection
6K = dust-tight

Second digit: Protection against water
4K = protection against splashing water from any direction with increased pressure
7 = protection against temporary immersion
9K = protection against water during high-pressure/steam-jet cleaning

Electronic circuit
2 different circuits are basically possible for LED lamps.



Active:
LED current regulation via active electronics.



Passive:
Setting a specific voltage range for the LED by means of a series resistor.



Active:
Electronic power control of the LEDs at high ambient temperatures exceeding permitted levels. This ensures the LEDs are protected against destruction caused by overheating.

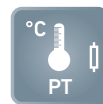

Passive:
Optimised layout of the components for even temperature distribution and dissipation.



Reverse polarity protection
Even if the connecting cable is connected the wrong way round, there is still no danger for the electronics.



Electromagnetic compatibility
Electromagnetic compatibility (EMC) tested and EU type approval issued.









Tourist solution (passive)
The light can be used without adjustments for a short time in countries with left-hand traffic.

Universal headlamp modules at a glance

LED

90 MM MODULES

LOW BEAM	HIGH BEAM	LOW BEAM AND HIGH BEAM	FOG LIGHT
Performance:			
 <p>L 4060 Page 10</p>	 <p>L 4060 Page 12</p>	 <p>Bi-LED L 5570 Page 16</p>	 <p>L 4060 Page 14</p>
Essential:			
 <p>R 80 Page 8</p>	 <p>R 80 Page 8</p>		

HALOGEN

Essential*:		Performance**:
 <p>Page 20</p>	 <p>Page 21</p>	 <p>Page 20</p>

* former category Classic
 ** former category Premium



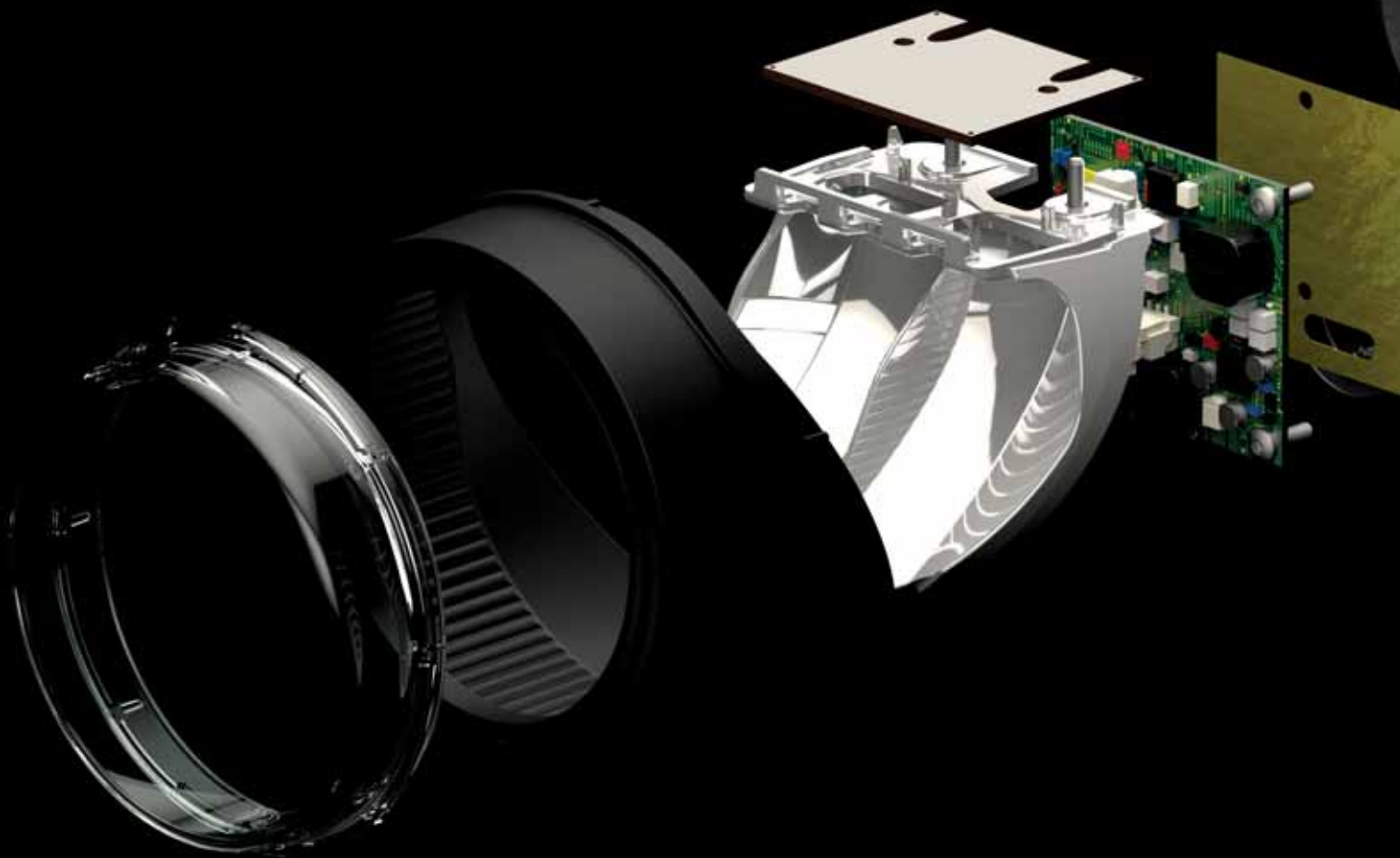

LED low beam headlamp R 80

Right-hand traffic, ECE, DEUTSCH connector	1B0 015 050-001*
Left-hand traffic, ECE, DEUTSCH connector	1M0 015 050-011*
SAE, DEUTSCH connector	1B0 015 050-031*
SAE, DEUTSCH connector	1B0 015 050-151**
Right-hand traffic, ECE, FEP connector	1B0 015 050-101*
Left-hand traffic, ECE, FEP connector	1M0 015 050-111*
SAE, FEP connector	1B0 015 050-131*



LED high beam headlamp R 80

ECE, SAE, DEUTSCH connector	1K0 015 050-021*
ECE, SAE, DEUTSCH connector	1K0 015 050-141**
ECE, SAE, FEP connector	1K0 015 050-121*

* Mounting kit 9XX 254 163-00 not included in delivery.

** Mounting kit 9XX 254 163-00 included in delivery. Available in 2nd quarter 2021



LED

90 MM MODULES – ESSENTIAL LOW BEAM AND HIGH BEAM

SPECIFICATIONS

- Specially developed reflector design for homogeneous illumination
- Compact and robust design
- Enables cost-effective switch from halogen to LED
- Optionally FEP or DEUTSCH connector

ECE	R112	SAE	9-32V	°C -40 – +60°C	IP X9K IP X4K IP 5KX	PE
°C PT	PRP	EMC CLASS 5				

For further information on each product, see general overview on page 28

Dimensional sketches of the low beam and high beam headlamp R 80

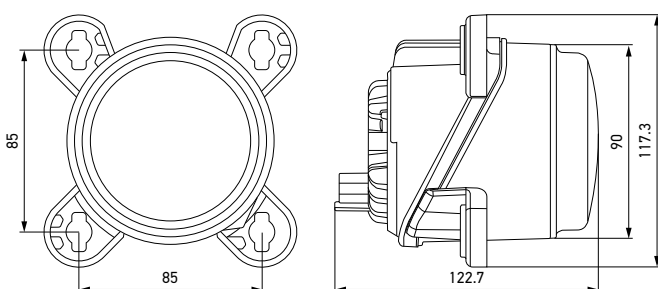

To the product video



FAR EXCEEDING THE STANDARD

Are you interested in a customised lighting solution that is perfectly suited to your vehicle? Then we're the ideal partner for you!

Just get in touch with us. More information on p. 31.

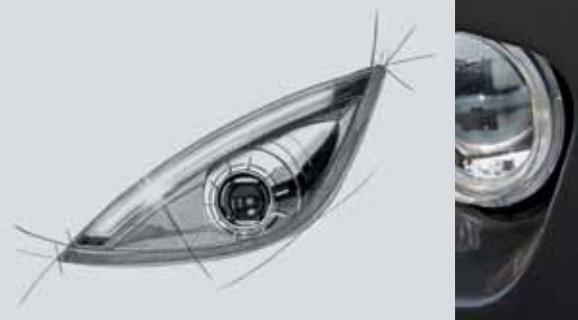

LED low beam headlamp L 4060*

Right-hand traffic, ECE, SAE, FEP connector	1BL 012 488-001
Left-hand traffic, ECE, FEP connector	1ML 012 488-011
Right-hand traffic, ECE, SAE, DEUTSCH connector	1BL 012 488-101
Left-hand traffic, ECE, DEUTSCH connector	1ML 012 488-111



LED low beam headlamp L 4060 with daytime running/position light*

Right-hand traffic, ECE, SAE, FEP connector	1BL 012 488-021
Left-hand traffic, ECE, FEP connector	1ML 012 488-031
Right-hand traffic, ECE, SAE, DEUTSCH connector	1BL 012 488-121
Left-hand traffic, ECE, DEUTSCH connector	1ML 012 488-131
Right-hand traffic, ECE, FEP connector, with fording ability**	1BL 012 488-041

* Mounting kit 9XX 254 163-02 and 9XX 254 163-00 included in delivery.

** More information on p. 24.

LED

90 MM MODULES – PERFORMANCE LOW BEAM

SPECIFICATIONS

- Homogenous high-end illumination similar to daylight thanks to innovative LED technology
- Low beam, daytime running light and position light in one module or as a separate low beam
- Simple conversion from halogen to LED possible
- Optionally FEP or DEUTSCH connector
- Individual front design thanks to modular design of the 90 mm series

Photo: © VDL Bus & Coach bv



For further information on each product, see general overview on page 28

Dimensional sketches of the LED low beam headlamp L 4060

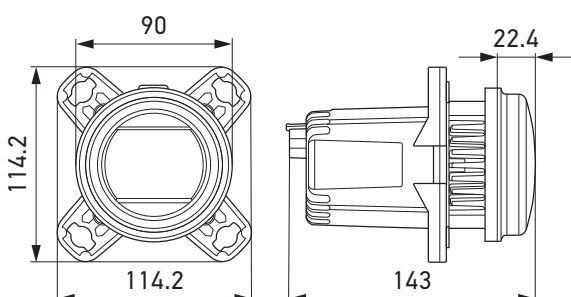



DID YOU KNOW?

Malfunctions of the high beam (HB) with direction indicator (DI) module can normally be detected with the vehicle control unit. The stages of detection are as follows: DI: < 400 mA // HB: < 800 mA

If your control unit cannot detect stage < 400 mA for DI, the pulse generator will increase the amperage in an interval of 100 to 120 ms to simulate the level consistent with a standard 12 V (21 W) bulb.



LED high beam headlamp L 4060

With pre-assembled carrier frame	1F0 011 988-021
For Performance mounting	1F0 011 988-121*



**LED high beam headlamp L 4060
with daytime running/position light**

With pre-assembled carrier frame	1F0 011 988-031
For Performance mounting	1F0 011 988-131*

* Mounting kit 9XX 254 163-00 and 9XX 254 163-02 included in delivery.

** More information on p. 24.

LED

90 MM MODULES – PERFORMANCE HIGH BEAM

SPECIFICATIONS

- High-end illumination thanks to innovative LED technology
- High beam, daytime running and position lights in one module, a high beam/direction indicator light combination or high beam as a separate module
- Simple conversion from halogen to LED possible
- Robust die-cast aluminium housing with integrated driver electronics and FEP connector
- Individual front design thanks to modular design of the 90 mm series

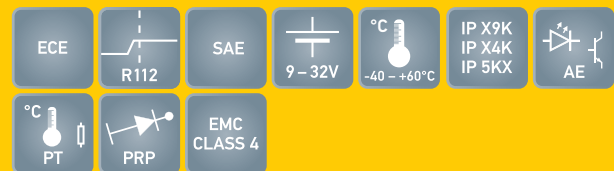

For further information on each product, see general overview on page 28



LED high beam headlamp L 4060 with direction indicator

With pulse generator and pre-assembled carrier frame	1F0 011 988-081
With pulse generator, for Performance mounting	1F0 011 988-181*
Without pulse generator and with pre-assembled carrier frame	1F0 011 988-071
Without pulse generator, for Performance mounting	1F0 011 988-171*
With pulse generator, for Performance mounting, with fording ability**	1F0 011 988-191*

The direction indicator only fulfills SAE type approval for vehicles < 80" wide.

Dimensional sketches of the LED high beam headlamp L 4060

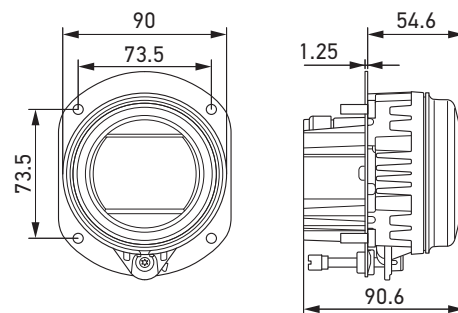

With pre-assembled carrier frame

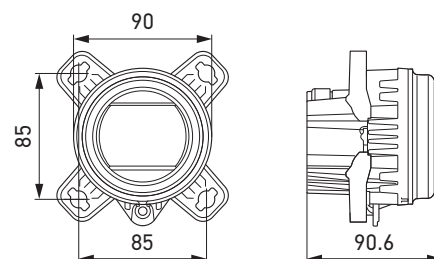

Without carrier frame



LED fog lamp L 4060

Without daytime running/position light	1N0 011 988-001
With daytime running/position light	1N0 011 988-011

Dimensional sketches of the LED fog lamp L 4060

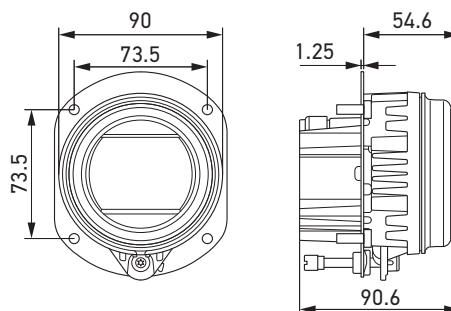

With pre-assembled carrier frame

LED

90 MM MODULES – PERFORMANCE FOG LIGHT

SPECIFICATIONS

- Homogenous illumination, similar to daylight
- Fog light in various combinations or as a separate module, with daytime running light, position light or with cornering light
- Simple conversion from halogen to LED possible
- Robust die-cast aluminium housing with integrated driver electronics and FEP connector
- Weight saving thanks to polycarbonate lens
- Individual front design thanks to modular design of the 90 mm series
- With pre-assembled carrier frame



For further information on each product, see general overview on page 28

Photo: © RAPIDO Reisemobile



LED fog lamp L 4060 with cornering light

Left headlamp	1N0 011 988-051
Right headlamp	1N0 011 988-061

Optional accessories

Cornering light control unit, PU: 24	5DF 009 244-007
Termination cable LED module control unit, length: 2,600 mm	8KB 163 160-811

Dimensional sketches of the LED fog lamp L 4060 with cornering light

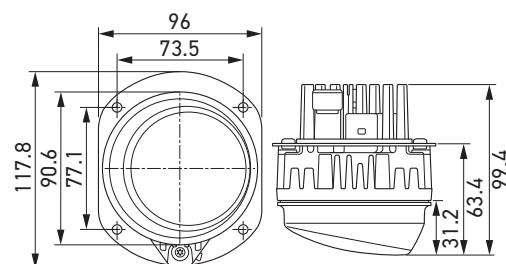

With pre-assembled carrier frame



The L 5570 modules are equipped with an integrated function monitoring system that monitors power consumption as an alternative to the vehicle. There is a separate PIN for the function confirmation signal.

Dimensional sketches of the Bi-LED low beam and high beam headlamp L 5570

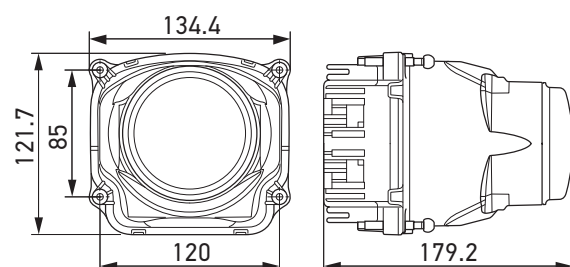

Bi-LED low beam and high beam headlamp L 5570*

Right-hand traffic, ECE, 4-pin FEP connector	1AL 012 758-001
Left-hand traffic, ECE, 4-pin FEP connector	1LL 012 758-011
SAE, 4-pin FEP connector	1AL 012 758-021
Right-hand traffic, ECE, 4-pin DEUTSCH connector	1AL 012 758-101
Left-hand traffic, ECE, 4-pin DEUTSCH connector	1LL 012 758-111
SAE, 4-pin DEUTSCH connector	1AL 012 758-121

* Mounting kit 9XX 202 748-00 included in delivery.

BI-LED

90 MM MODULES – PERFORMANCE

LOW BEAM AND HIGH BEAM

SPECIFICATIONS

- Excellent low beam and high beam from a single headlamp module
- Non-patterned projection of light through polycarbonate lens from the reflector in the required direction
- Bi-LED module L5570 with advanced lighting electronics
- Optionally FEP or DEUTSCH connector for L 5570 modules



For further information on each product, see general overview on page 28



Bi-halogen low beam and high beam headlamp

12 V, H7, right-hand traffic, ECE	1AL 009 998-001*
12 V, H7, left-hand traffic, ECE	1LL 009 998-011*
12 V, H9, SAE	1AL 009 998-021**
24 V, H7, right-hand traffic, ECE	1AL 009 998-041***
24 V, H7, left-hand traffic, ECE	1LL 009 998-051***
24 V, H7, right-hand traffic, ECE, with fording ability	1AL 009 998-201*
24 V, H7, left-hand traffic, ECE, with fording ability	1LL 009 998-221*

* Mounting kit 9XX 202 748-00 included in delivery.

** Mounting kit 9XX 169 098-01 included in delivery.

*** Mounting kit 9XX 169 098-00 included in delivery.

BI-HALOGEN

90 MM MODULES – PERFORMANCE

LOW BEAM AND HIGH BEAM

SPECIFICATIONS

- Excellent light output and homogenous illumination with little scattered light thanks to non-patterned 70 mm lens
- Low beam and high beam from a single headlamp module
- Pattern-free and hardened glass cover lens for a direct view of the lens
- High-quality aluminium reflector
- Pre-assembled adjusting screws for easy assembly
- High beam activated by simultaneous control of high beam shutter and bulb

ECE



SAE



IP 5K4K

For further information on each product, see general overview on page 29

Dimensional sketches of the Bi-halogen low beam and high beam headlamp

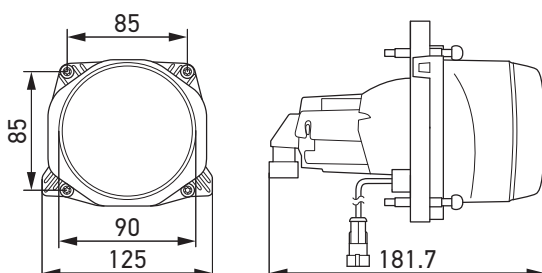



Dimensional sketches of the halogen low beam headlamp

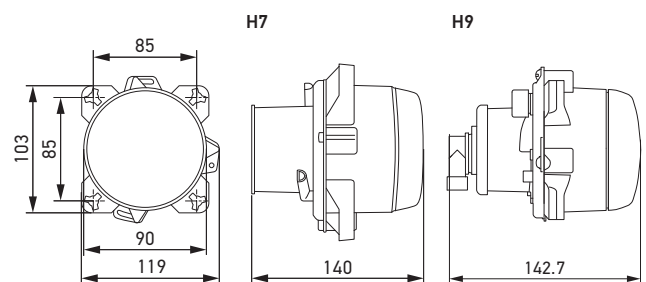

Halogen low beam headlamp

12 V, H7, right-hand traffic, ECE	1BL 008 193-001*
12 V, H9, SAE	1BL 008 193-021**
12 V, H7, left-hand traffic, ECE	1LL 008 193-111*
24 V, H7, right-hand traffic, ECE	1BL 008 193-011*
24 V, H7, left-hand traffic, ECE	1LL 008 193-121*

Dimensional sketches of the caps for H7 versions

(not included in delivery, but necessary accessories; for more information see p. 27)

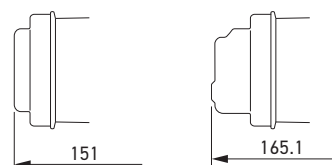

* Mounting kit 9XB 152 977-00 included in delivery.
 ** Mounting kit 9XB 152 977-02 included in delivery.

HALOGEN

90 MM MODULES – ESSENTIAL LOW BEAM AND HIGH BEAM

SPECIFICATIONS

- Proven illumination
- Pattern-free and hardened glass cover lens
- Magnesium reflector
- Low beam with 50 mm DE lens, high beam with free-form reflector



For further information on each product, see general overview on page 29



Halogen high beam headlamp

12 V, H7, ECE, with position light	1K0 008 191-001*
12 V, H7, ECE, without position light	1K0 008 191-011*
12 V, H9, SAE, with position light	1K0 008 191-131*
12 V, H9, SAE, without position light	1K0 008 191-051*
24 V, H7, ECE, with position light	1K0 008 191-021*
24 V, H7, ECE, without position light	1K0 008 191-041*

Dimensional sketches of the halogen high beam headlamp

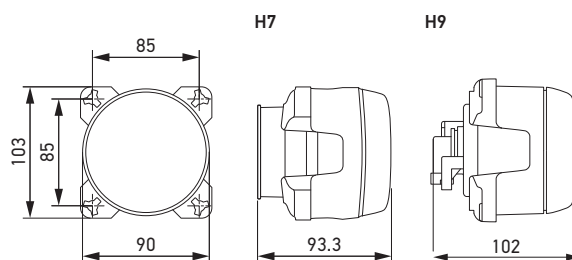

Dimensional sketches of the caps for H7 versions

(not included in delivery, but necessary accessories; for more information see p. 27)

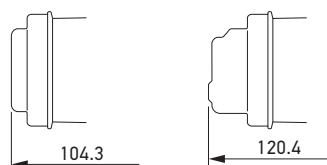

Light distributions 90 mm modules

Low beam comparison

LED Performance L 4060
(012 488)

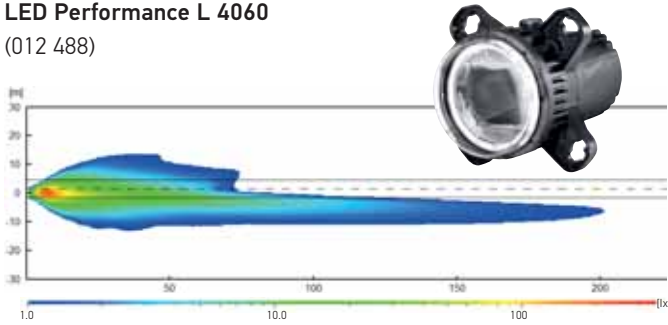

LED Essential R 80
(015 050)

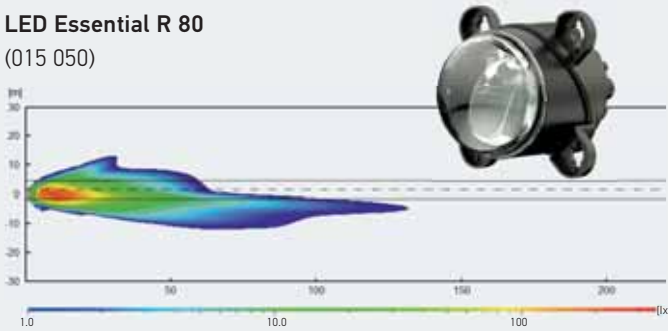

Halogen Essential
(008 193)

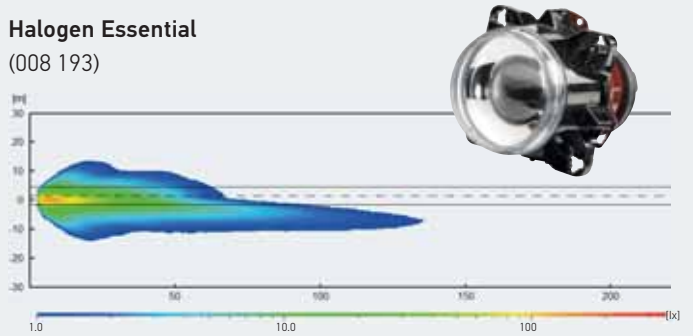

Bi-LED Performance L 5570
(012 758)

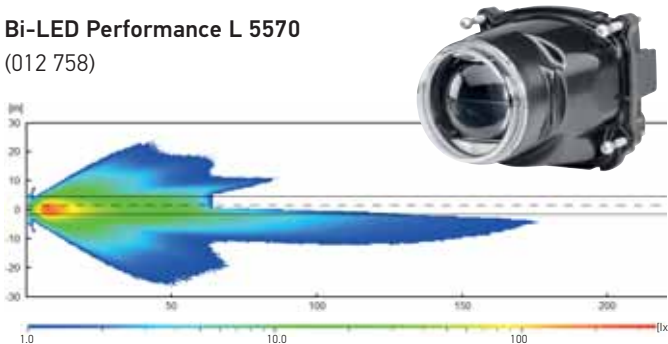

Bi-halogen Performance
(009 998)

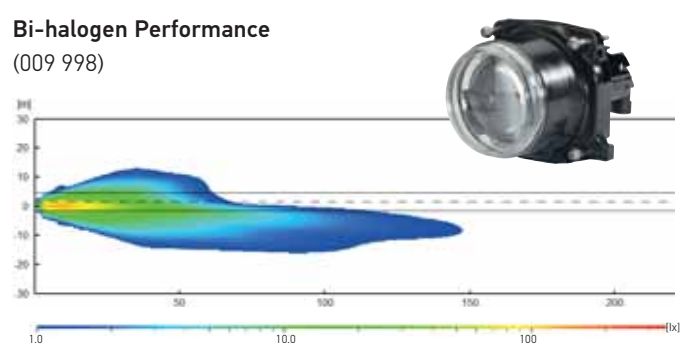

Legend, isolux diagram (1 - 350 lux)

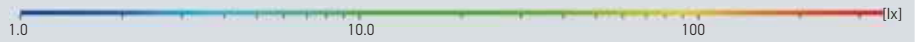

Remarks

Headlamp mounting height: 0.65 m
Spacing between the headlamps: 1.20 m

High beam comparison (incl. low beam)

LED Performance L 4060
(011 988 + 012 488)

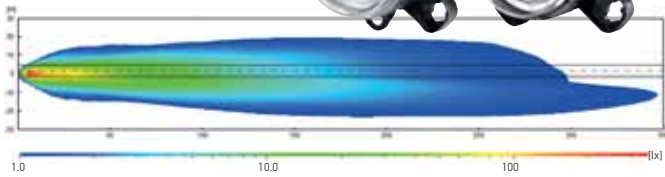

LED Essential R 80
(015 050)

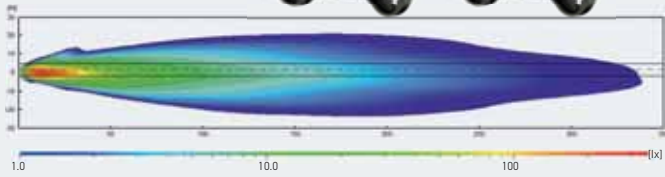

Halogen Essential
(008 191 + 008 193)

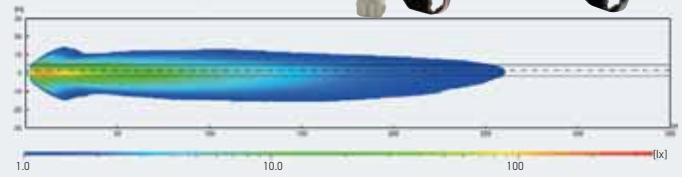

Bi-LED Performance L 5570
(012 758)

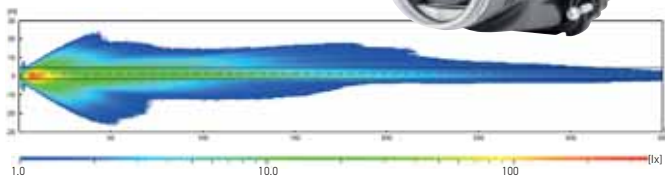



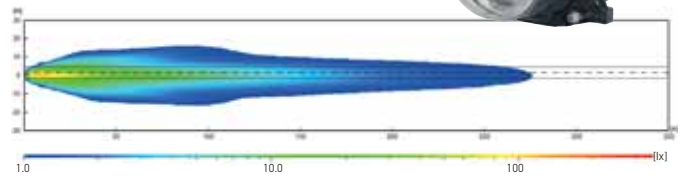





Bi-halogen Performance
(009 998)

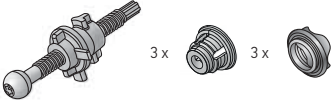

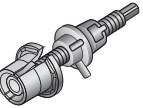
Important:

Representation of high beam including low beam as high beam is supplemented by low beam during driving.
Bi-light distributions are generated when low beam is switched on and are only available as a bi-version.

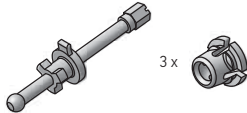
Overview of mounting kits for 90 mm modules

Article number	Product image	PU	Article number	Product image	PU
9XX 254 163-007	3 x 	200 units	9XX 169 098-007	3 x 	200 units
9XX 254 163-027	3 x 	200 units	9XX 169 098-017	3 x  2 x  Locking element for SAE version	100 units
9XX 202 748-001	3 x 	1 unit	9XB 152 977-001/-007	3 x 	1 unit/ 200 units
9XX 236 655-001	3 x 	200 units	9XX 152 977-02	See 9XB 152 977-001/-007 plus USA assembly instructions; to reorder please use 9XB 152 977-001/-007	

INSTALLATION EXAMPLES

Installation example 1
Without carrier frame

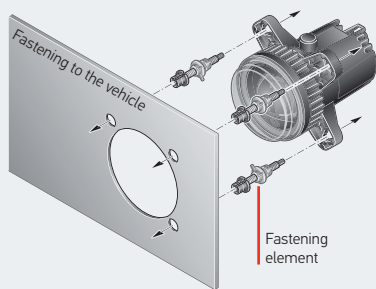

Installation example 2
With pre-assembled carrier frame

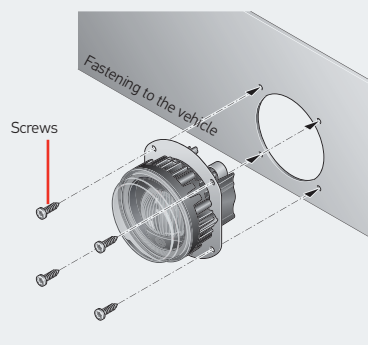



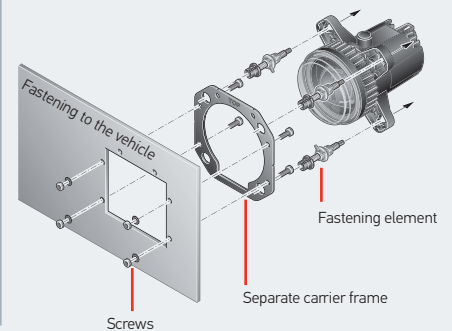



Installation example 3
With additional carrier frame



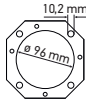

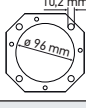

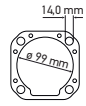
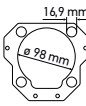
Important note:

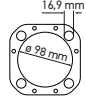
The relevant country-specific statutory specifications and regulations for motor vehicles must be observed when installing headlamps!

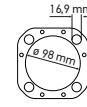
Carrier frames for 90 mm modules

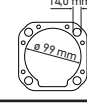
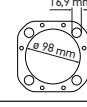
Product family	Matching carrier frame	Dimensions	Panel thickness	Matching mounting kit
Halogen / Essential				
	008 191 9AH 157 659-007		1.25 to 1.5 mm	9XB 152 997-001
	008 193 9AH 157 659-007		1.25 to 1.5 mm	9XB 152 997-001
Halogen / Performance				
	009 998 9AH 169 580-011		3 mm	9XX 169 098-007 9XX 202 748-001
	For high vibration requirements 9AH 185 978-011		3 mm	9XX 169 098-011 9XX 202 748-001
LED / Essential				
	015 050 9AH 254 228-012		3 mm	9XX 254 163-007

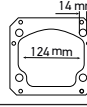
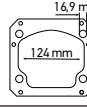
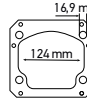
Product family	Matching carrier frame	Dimensions	Panel thickness	Matching mounting kit
LED / Performance				
	011 988 9AH 254 228-012*		3 mm	9XX 254 163-007 9XX 254 163-027
	012 488 9AH 169 580-011*		3 mm	9XX 254 163-007 9XX 254 163-027
	For high vibration requirements 9AH 254 228-012		3 mm	9XX 254 163-007 9XX 254 163-027
	012 758 9AH 205 652-011*		3 mm	9XX 202 748-001
	For high vibration requirements 9AH 205 652-111*		3 mm	9XX 202 748-001
	For high vibration requirements 9AH 205 652-111		3 mm	9XX 236 655-001

* For simple replacement with other products in the 90 mm series.

Accessories for 90 mm modules

(not included in delivery)

Connectors

Product image	Description	Article number	PU
Surplus supply LED: AMP SUPERSEAL connector, 3-pin			
	Housing	8JA 746 184-032	10 units
	Female socket connector	8KW 744 837-002	50 units
	Strand insulation	9GD 746 185-002	50 units
Surplus supply LED: FEP connector, 4-pin			
	Housing	8JA 202 231-002	10 units
	Flat contact	8KW 863 933-013	50 units
	Strand insulation 0.35 – 0.5 mm ²	9GD 863 952-022	50 units
	Strand insulation 0.75 mm ²	9GD 863 952-012	50 units
	Blind plug	9GD 863 952-002	50 units
Surplus supply LED: DEUTSCH connector, 4-pin (in conjunction with adapter cable 8KA 202 117-001, except for 012 488-1xx and 012 758-1xx)			
	Male connector housing	8JA 201 022-042	10 units
	Lock / wedgelock	9NB 201 024-042	10 units
	Contact sleeve 0.5 – 1.5 mm ²	8KW 201 025-112	50 units
	Blind plug	9NB 201 026-012	50 units
	Set packaging	8JA 201 022-821	

Product image	Description	Article number	PU
Surplus supply halogen: connector			
	Surplus supply H1 / H7	8JD 156 151-807	20 systems
	Surplus supply H9	8JD 158 175-807	20 systems
	Parking light	8JD 156 150-807	20 systems
	Housing	8JA 746 184-022	10 units
	Female socket connector	8KW 744 837-002	50 units
	Strand insulation	9GD 746 185-002	50 units

Caps

Product image	Description	Article number	PU
Flat version for angled connectors			
	Vented	9GH 152 654-007	252 units
	Non-vented	9GH 152 654-012	36 units
Deep version for female connector housing			
	Vented	9GH 145 943-001	24 units
	Non-vented	9GH 145 943-012	36 units

Type approvals

	Article number	Main light functions	Auxiliary light functions	Variant	Weight	Voltage	Light source	ECE test mark	Approval		
									R112 B	R113 D	SAE
90 mm modules LED – Performance	1BL 012 488-001	LB	–	ES	763 g	Multi-voltage	LED	Ⓔ 3831	x		x
	1ML 012 488-011	LB	–	LES	763 g	Multi-voltage	LED	Ⓔ 4090	x		
	1BL 012 488-101	LB	–	ES	764 g	Multi-voltage	LED	Ⓔ 3881	x		x
	1ML 012 488-111	LB	–	LES	764 g	Multi-voltage	LED	Ⓔ 4090	x		
	1BL 012 488-021	LB	DRL / PO	ES	782 g	Multi-voltage	LED	Ⓔ 3831	x		x
	1ML 012 488-031	LB	DRL / PO	LES	780 g	Multi-voltage	LED	Ⓔ 4090	x		
	1BL 012 488-121	LB	DRL / PO	ES	783 g	Multi-voltage	LED	Ⓔ 3881	x		x
	1ML 012 488-131	LB	DRL / PO	LES	781 g	Multi-voltage	LED	Ⓔ 4090	x		
	1BL 012 488-041	LB	DRL / PO	ES	824 g	Multi-voltage	LED	Ⓔ 3831	x		
	1FO 011 988-021	HB	–	–	519 g	Multi-voltage	LED	Ⓔ 3831	x		x
	1FO 011 988-121	HB	–	–	552 g	Multi-voltage	LED	Ⓔ 3831	x		x
	1FO 011 988-031	HB	DRL / PO	–	524 g	Multi-voltage	LED	Ⓔ 3831	x		x
	1FO 011 988-131	HB	DRL / PO	–	556 g	Multi-voltage	LED	Ⓔ 3831	x		x
	1FO 011 988-081	HB	DI	–	584 g	Multi-voltage	LED	Ⓔ 3831	x		x
	1FO 011 988-181	HB	DI	–	616 g	Multi-voltage	LED	Ⓔ 3831	x		x
	1FO 011 988-071	HB	DI	–	524 g	Multi-voltage	LED	Ⓔ 3831	x		x
	1FO 011 988-171	HB	DI	–	556 g	Multi-voltage	LED	Ⓔ 3831	x		x
	1FO 011 988-191	HB	DI	–	624 g	Multi-voltage	LED	Ⓔ 3831	x		x
	1NO 011 988-001	FL	–	–	521 g	Multi-voltage	LED	Ⓔ 3831	x		x
	1NO 011 988-011	FL	DRL / PO	–	527 g	Multi-voltage	LED	Ⓔ 3831	x		x
	1NO 011 988-051	FL	CL L	–	516 g	Multi-voltage	LED	Ⓔ 3832	x		x
	1NO 011 988-061	FL	CL R	–	516 g	Multi-voltage	LED	Ⓔ 3832	x		x
	1AL 012 758-001	Bi	–	ES	1.280 g	Multi-voltage	LED	Ⓔ 4208	x		
	1LL 012 758-011	Bi	–	LES	1.280 g	Multi-voltage	LED	Ⓔ 4209	x		
1AL 012 758-021	Bi	–	–	1.280 g	Multi-voltage	LED				x	
1AL 012 758-101	Bi	–	ES	1.280 g	Multi-voltage	LED	Ⓔ 4208	x			
1LL 012 758-111	Bi	–	LES	1.280 g	Multi-voltage	LED	Ⓔ 4209	x			
1AL 012 758-121	Bi	–	–	1.280 g	Multi-voltage	LED				x	

	Article number	Main light functions	Auxiliary light functions	Variant	Weight	Voltage	Light source	ECE test mark	Approval		SAE
									ECE R112 B	R113 D	
90 mm modules LED – Essential	1B0 015 050-001	LB	–	ES	445 g	Multi-voltage	LED	Ⓔ 0007	x		
	1M0 015 050-011	LB	–	LES	445 g	Multi-voltage	LED	Ⓔ 0008	x		
	1B0 015 050-101	LB	–	ES	445 g	Multi-voltage	LED	Ⓔ 0007	x		
	1M0 015 050-111	LB	–	LES	445 g	Multi-voltage	LED	Ⓔ 0008	x		
	1B0 015 050-031	LB	–	–	445 g	Multi-voltage	LED	–			x
	1B0 015 050-131	LB	–	–	445 g	Multi-voltage	LED	–			x
	1K0 015 050-021	HB	–	–	445 g	Multi-voltage	LED	Ⓔ 0009	x		x
	1K0 015 050-121	HB	–	–	445 g	Multi-voltage	LED	Ⓔ 0009	x		x
90 mm modules Halogen – Performance	1AL 009 998-001	Bi	–	ES	783 g	12 V	Halogen H7	Ⓔ 2484	x		
	1LL 009 998-011	Bi	–	LES	820 g	12 V	Halogen H7	Ⓔ 2485	x		
	1AL 009 998-021	Bi	–	–	794 g	12 V	Halogen H9				x
	1AL 009 998-041	Bi	–	ES	820 g	24 V	Halogen H7	Ⓔ 2484	x		
	1LL 009 998-051	Bi	–	LES	820 g	24 V	Halogen H7	Ⓔ 2485	x		
	1AL 009 998-201	Bi	–	ES	820 g	24 V	Halogen H7	Ⓔ 2484	x		
	1LL 009 998-221	Bi	–	LES	820 g	24 V	Halogen H7	Ⓔ 2485	x		
90 mm modules Halogen – Essential	1BL 008 193-001	LB	–	ES	475 g	12 V	Halogen H7	Ⓔ 917	x		
	1BL 008 193-021	LB	–	–	448 g	12 V	Halogen H9				x
	1LL 008 193-111	LB	–	LES	475 g	12 V	Halogen H7	Ⓔ 917	x		
	1BL 008 193-011	LB	–	ES	479 g	24 V	Halogen H7	Ⓔ 917	x		
	1LL 008 193-121	LB	–	LES	393 g	24 V	Halogen H7	Ⓔ 917	x		
	1K0 008 191-001	HB	PO	–	264 g	12 V	Halogen H7	Ⓔ 917	x		
	1K0 008 191-011	HB	–	–	278 g	12 V	Halogen H7	Ⓔ 917	x		
	1K0 008 191-131	HB	PO	–	311 g	12 V	Halogen H9	Ⓔ 1265	x		x
	1K0 008 191-051	HB	–	–	291 g	12 V	Halogen H9	Ⓔ 1265	x		x
	1K0 008 191-021	HB	PO	–	291 g	24 V	Halogen H7	Ⓔ 917	x		
1K0 008 191-041	HB	–	–	287 g	24 V	Halogen H7	Ⓔ 917	x			

LB: Low beam
HB: High beam
Bi: Low beam and high beam

PO: Position light
DRL: Daytime running light
DI: Direction indicator light

ES: Right-hand traffic
LES: Left-hand traffic
SAE: USA

FL: Fog light
CL: Cornering light

FAQ

Important information at a glance

→ **Do HELLA headlamps satisfy functional safety requirements?**

All HELLA LED low beam headlamps (and front direction indicators) have been developed in accordance with the ISO 26262 functional safety standard.

→ **Do I need a headlamp levelling system for low beam?**

This varies, depending on the vehicle. The decisive factor is the extent to which the light cone of the headlamp changes when the vehicle is loaded. If regulation is necessary, this can be controlled either manually using a rotary switch or automatically using inclination sensors. If however the low beam headlamp produces more than 2,000 lumens, control must always be automatic.

→ **Which headlamp levelling system can be used?**

Further information can be found on page 39 of this brochure.

→ **How many adjustments must be possible for a headlamp?**

If a headlamp levelling system is necessary, the extent of movement of the headlamp must cover the full range of the anticipated inclination of the vehicle.

→ **What characterises a product with fording ability?**

Lighting products with fording ability are used on vehicles that briefly drive through waterways, streams or rivers in off-road situations. Here the vehicle can be immersed in water up to the maximum fording depth (water depth) specified in each case, or the bow wave may briefly wash over the front of the vehicle up to the maximum fording depth. A suitably designed seal prevents damage to headlamps with fording ability through the ingress of water up to a specified water pressure (e.g. up to 0.6 bar).

→ **Can the LED lamps be used with pulse width modulation?**

Our LED modules have not been developed for pulse width modulation. Please ask about our accessories here.

→ **How many lumens do the LED modules produce?**

All our LED modules have a lumen output of < 2,000 lumens so that no regulator is necessary.

→ **Can halogen modules be upgraded to LED?**

HELLA's LED modules are similar to the halogen modules in terms of physical structure so that they can be easily replaced or upgraded. Consideration should however be given to electronic modifications required due to the reduced power requirements of LED modules and fault monitoring by the vehicle lighting control system.

→ **What do the abbreviations R112 and R113 mean?**

The abbreviations R112 and R113 stand for specific ECE vehicle headlamp standards. These statutory provisions must be observed to equip or retrofit parts to a vehicle to optimum effect. The specifications of ECE Regulation 48 include requirements for front lighting. Also ECE-R112 is required for most road vehicles. For light and slow-moving vehicles there is a separate standard, ECE-R113. Acceptance of the R113 standard varies within the ECE regulatory region, and the vehicle classifications indicating when this standard can be used likewise vary. The most noticeable feature of R113 is the symmetrical cut-off line for low beam (in contrast to R112 with a stepped cut-off line, which directs more light to the vehicle side of the road and less towards oncoming traffic).

Not all countries that follow the ECE regulations observe the provisions in every detail. There are some special extensions. We therefore recommend that every vehicle manufacturer checks all local requirements.

CONTACT

HELLA worldwide – a global network

Contact persons who would be pleased to answer any questions and offer assistance are available at the addresses listed below.
We are looking forward to exciting, groundbreaking projects.

HEADQUARTER

HELLA GmbH & Co. KGaA

Rixbecker Straße 75
59557 Lippstadt,
Deutschland

Tel.: +49 2941 38-0
info@hella.com
www.hella.com

AMERICA

HELLA, Inc.

201 Kelly Drive
P.O. Box 2665
Peachtree City,
GA 30269 USA

Tel.: +1 877 224-3552
www.hellausa.com

ASIA

HELLA Trading (Shanghai) Co. Ltd.

11th/F, Block 5, Daning Hub No. 1898 Gong
He Xin Road Shanghai 200072
P. R. China

Tel.: +86 21 6117-6228
www.hellacn.com

HELLA India Lighting Ltd.

6th Floor, Platinum
Tower, Plot no. 184,
Udyog Vihar Phase-1
Gurgaon -122016

Tel.: +91 124 4658600
www.hella.co.in

AUSTRALIA AND OCEANIA

HELLA Australia Pty Ltd

4 Hargrave Place
Mentone, VIC, 3194, AUSTRALIA
P.O. Box 89, Mentone, VIC, 3194
AUSTRALIA
Tel +61 1800 061 729
Email: info.au@hella.com
www.hella.com.au

HELLA - New Zealand Limited

81 - 83 Ben Lomond Crescent
Pakuranga, Auckland
PO Box 51-427, Auckland, 2140
Telephone: (09) 577 0000
Facsimile: (09) 576-2476
Internet: www.hella.co.nz

EUROPE

HELLA Fahrzeugteile Austria GmbH

Handelskai 94-96
1200 Wien, Österreich

Tel.: +43 1 60689-20
info-ag-ce@hella.at
www.hella.com/agro

HELLA Limited

Unit 6 Appletree
Industrial Estate
Chipping Warden
Banbury,
Oxon OX17 1LL,
England, UK

Tel.: +44 1295 662400
hella.sales@hella.com
www.hella.co.uk

HELLA S.A.S.

B.P. 7
11 av Albert Einstein
93151 Le Blanc
Mesnil Cedex

Téléphone:
0149395959
E-Mail:
info.fr@hella.com
Internet: www.hella.fr

HELLA Benelux BV

Celsiusbaan 2,
Postbus 1398
3430 BJ Nieuwegein,
Nederland

Tel.: +31 30 6095611
nl.info@hella.com
www.hella.nl

HELLA S.p.A.

Via B. Buozzi, 5
20090 - Caleppio di
Settala, Italia

Tel.: +39 2 98835-1
infoitalia@hella.com
www.hella.it

HELLA Romania SRL

Tapiei No. 55
Lugoj, 305500
Romania

Tel.: + ??
www.hella.ro

HELLA Automotive Sales, Inc.

201 Kelly Drive

P.O. Box 2665

Peachtree City, GA 30269

Toll Free: 1-877-224-3552

Fax: 1-800-631-7575

www.hellausa.com

© HELLA GmbH & Co. KGaA, Lippstadt

J01757/01.21

Subject to technical and price modifications

